

PROTECTING THOSE WHO PROTECT OTHERS

FIELD SERIES • WHELEN ENGINEERING COMPANY, INC.



FIELD SERIES™



THE ONLY BROW LIGHT THAT FEATURES
ALL-NEW REVOLUTIONARY DYNAMIC BEAM TECHNOLOGY

WHELEN
MANUFACTURED IN AMERICA

FIELD SERIES™

After months of gathering feedback from firefighters across the country, designing and manufacturing our latest innovation piece by piece, and meticulously testing designs in our optical labs and out in the field, we're proud to present you with the all-new Field Series™ Brow Light – the only brow light that illuminates your entire field of vision using our revolutionary dynamic beam technology to provide advanced control and maximum visibility with the flip of a switch.

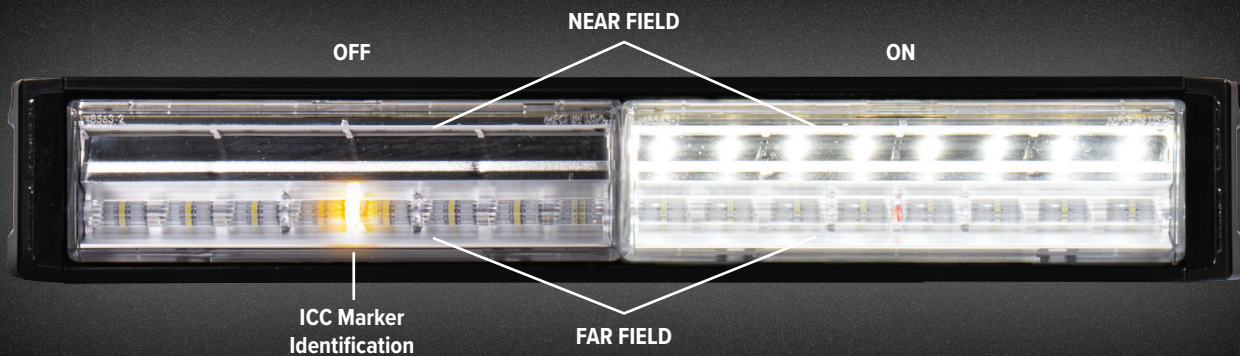

Engineer Kris Terpe works on our Field Series Brow Light to ensure it is optimized to safeguard first responders on every scene. His dedication and skill contribute to our mission to craft America's best products and helps to ensure our legacy of excellence endures.

WHELEN
MANUFACTURED IN AMERICA

WARNING: This product may contain chemicals known to the State of California to cause cancer and birth defects or other reproductive harm. For more information, visit whelen.com/regulatory.

**FIELD
SERIES™**

AMERICAN INNOVATION FROM START TO FINISH

When you show up at a scene, you follow protocol. You don't cut corners. You move with purpose and make sure the job is done right every time. So do we.

We don't launch a product until we're certain that it will be the best and safest asset for your critical missions. Because you deserve products that are designed and manufactured with the same intentionality and commitment to excellence that you show every single day.

The Field Series™ is a testament to our longstanding tradition of vertical integration with every step of the process being completed by our employees right here in America.

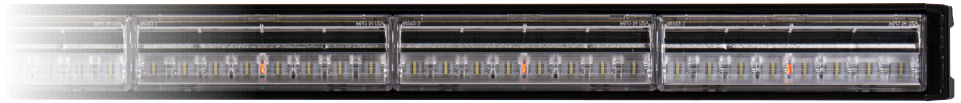

ENGINEERING

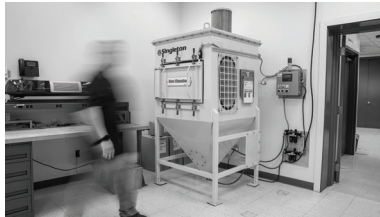

ENVIRONMENTAL TESTING



TOOLING

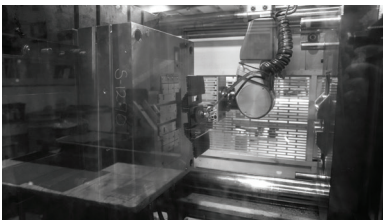

INJECTION & VACUUM MOLDING



FABRICATION



HARD-COATING



ASSEMBLY



QUALITY CONTROL & TESTING



LIFETIME WARRANTY

The Field Series™ is backed by our Lifetime Warranty. You can trust that your Field Series brow light will perform at the highest level in even the harshest conditions and feel secure in the knowledge that, no matter what happens, your purchase is covered for the entire lifetime of your apparatus. Ask your Whelen sales representative for more information on our lifetime warranty.

FIELD
SERIES™

 WARNING: This product may contain chemicals known to the State of California to cause cancer and birth defects or other reproductive harm. For more information, visit whelen.com/regulatory.

WHELEN[®]
MANUFACTURED IN AMERICA

ILLUMINATE YOUR **ENTIRE** FIELD OF VISION: REVOLUTIONARY BREAKTHROUGH OPTIC TECHNOLOGY

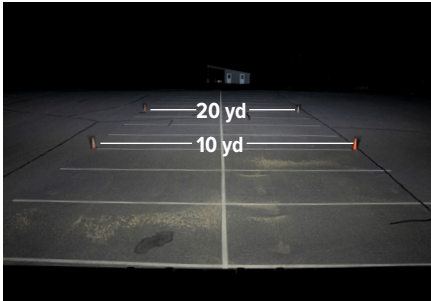

FAR FIELD

Light up the night with our Far Field optic technology that emits light in a wide and even spread at a greater distance than any other brow light on the market. You'll have full visibility of what lies ahead so you can act faster during critical missions when seconds count.

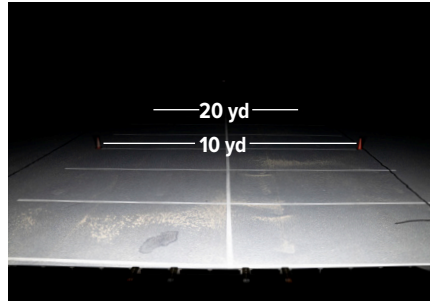

NEAR FIELD

Our Near Field optic technology directs the light spread down toward the ground providing precise illumination of the immediate area surrounding your apparatus. Operate with enhanced efficiency as you reach for the critical tools needed to get the job done.

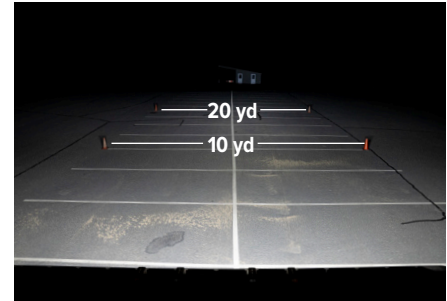

NEAR & FAR FIELD

Combine the precision of Near Field Optics with the depth of Far Field Optics for unmatched illumination that covers your entire field of vision. Combined optics allow you to maximize your efforts and stay safe on any scene.



WHELEN
MANUFACTURED IN AMERICA

 WARNING: This product may contain chemicals known to the State of California to cause cancer and birth defects or other reproductive harm. For more information, visit whelen.com/regulatory.

FIELD
SERIES™

VARIABLE POWER DISTRIBUTION

Put the light where you need it, when you need it most with variable power distribution which allows you to dynamically adjust how both optic paths are powered – either Near, Far, or a combination of both depending on the needs of the moment.



SELECTABLE TURN-ON FUNCTIONALITY

Much like our popular EZ Scene Lights™, the Field Series™ features multiple turn-on styles from instant to gradual that will allow you to use our brow light exactly as needed in any scenario.

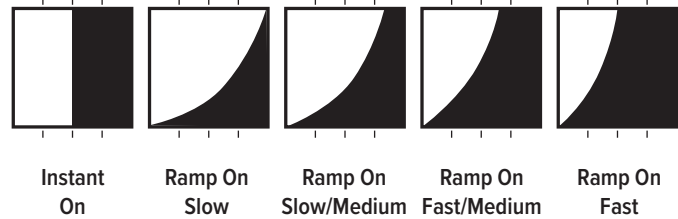

Stand Alone Model	Length	Number of Lamps
FSB02B	12"	Two
FSB03B	18"	Three
FSB04B	24"	Four
FSB05B	30"	Five
FSB06B	36"	Six
FSB07B	42"	Seven
FSB08B	48"	Eight
FSB09B	54"	Nine
FSB10B	60"	Ten
FSB11B	66"	Eleven
FSB12B	72"	Twelve
FSB13B	78"	Thirteen

Interconnect Model	Length	Number of Lamps
FSB02MB	12"	Two
FSB03MB	18"	Three
FSB04MB	24"	Four
FSB05MB	30"	Five
FSB06MB	36"	Six
FSB07MB	42"	Seven
FSB08MB	48"	Eight
FSB09MB	54"	Nine
FSB10MB	60"	Ten
FSB11MB	66"	Eleven

Replace the Last "B" in the Model Number with "W" for a White Housing

Option	Description
FSBCELR	Optional Left Rear Cable Exit, When Connecting Multiple Light Arrays, All Cable Exits Must Be on the Same Side.
FSBPS	Power Supply for Up to 13 Lamps Total, with Scan-Lock™ Lighting Features and Low Power.
FSBPC10	10' Power Supply Input Harness. No Charge When Purchasing FSBPS.
FSBPC25	25' Power Supply Input Harness. When Purchased with FSBPS, Additional Cost
FSBPC50	50' Power Supply Input Harness. When Purchased with FSBPS, Additional Cost
FSBPC75	75' Power Supply Input Harness. When Purchased with FSBPS, Additional Cost
FSBCC1	1' Interconnect Cable for Use When Connecting Multiple Light Arrays. One Required for Each Secondary Light Array. No Charge When Purchasing FSB.
FSBCC2	2' Interconnect Cable for Use with Two or Three Field Series Brow Light Arrays. One Required for Two Light Array Solution and Two Required for Three Light Array Solutions. No Charge When Purchasing FSB.
FSBCC3	3' Interconnect Cable for Use with Two or Three Field Series Brow Light Arrays. One Required for Two Light Array Solution and Two Required for Three Light Array Solutions. No Charge When Purchasing FSB.
FSBUB	Universal Adjustable Bracket Kit, Black (Curved). 2 Kits Required for 2-6 Light Array, 3 Kits for 7-10, 4 Kits for 11-12, and 5 Kits for 13.
FSBLPB	"L" Bracket Kit (Low Profile), Black. 2 Kits Required for 2-6 Light Array, 3 Kits for 7-10, 4 Kits for 11-12, and 5 Kits for 13.
FSBBB	Bail Bracket Kit (Pair), 1 Kit Required Per Light Array, Black. (Requires FSBCBB for 7-13 Light Arrays).
FSBCBB	Center Mounted Bracket Kit, Black. Required for 7 or More Light Arrays When Used with Bail Bracket. 7-10 Light Array Requires 1; 11-12 Light Array Requires 2; 13 Light Array Requires 3; When Not Using FSBBB Bail Bracket, 2 Kits Required for 2-6 Light Array; 3 Kits for 7-10; 4 Kits for 11-12; and 5 Kits for 13.
FSBLBB	Lightbar Bracket Kit, Black. 2 Kits Required for 2-6 Light Array; 3 Kits for 7-10; 4 Kits for 11-12; and 5 Kits for 13.

SYSTEM CONFIGURATION

Single Stick*



Two Stick*



Three Stick*

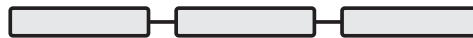

*Max 13 modules per power supply

PRODUCT HOUSING COLOR OPTIONS

White



Black



FIELD
SERIES™

WARNING: This product may contain chemicals known to the State of California to cause cancer and birth defects or other reproductive harm. For more information, visit whelen.com/regulatory.

WHELEN
MANUFACTURED IN AMERICA

SERVICEABILITY

We understand how important it is to keep your rigs ready for a call, which is why the Field Series[®] has been designed with serviceability in mind. Lighthouse modules are easily replaced within the overall structure of the brow light meaning there's no need to repurchase the entire unit just to replace a single module. And because the Field Series is backed by our Lifetime Warranty, replacements are covered for the entire lifetime of your apparatus.

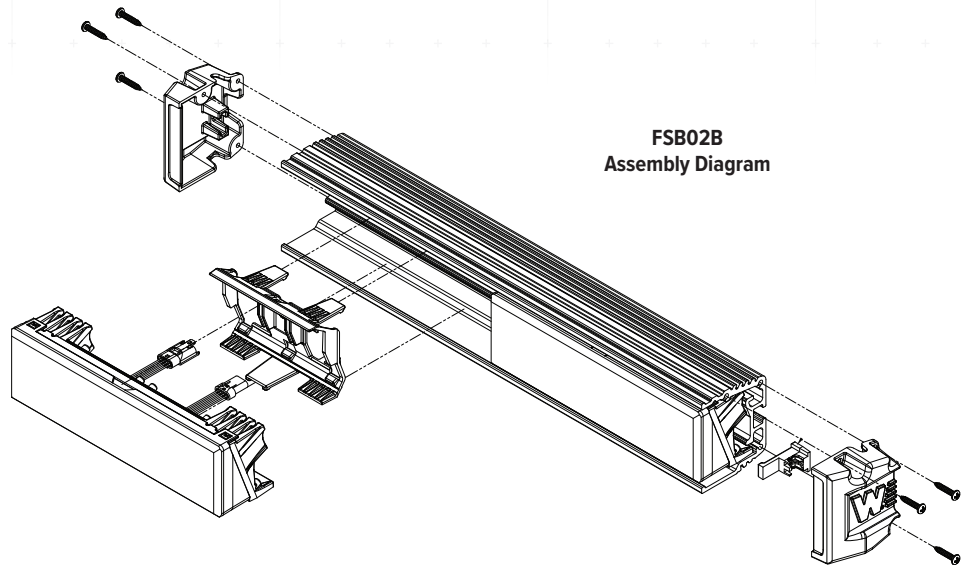

FSB02B
Assembly Diagram

SPECS & FEATURES

- Up to 13 Modules per Power Supply in multiple configurations
- Field Serviceable
- 10-30 VDC
- Power Supply and One Lighthouse at 12.8v: 1.3A Additional Lighthouse: 1.2A per lighthouse added
- 8 total inputs
- Low Current Switching
- Extruded aluminum Black or White powder-coated housing
- Hard-coated lenses
- Scan-Lock™

Stand Alone Model	Interconnect Model	Length	Number of Lamps
FSB02B	FSB02MB	12"	Two
FSB03B	FSB03MB	18"	Three
FSB04B	FSB04MB	24"	Four
FSB05B	FSB05MB	30"	Five
FSB06B	FSB06MB	36"	Six
FSB07B	FSB07MB	42"	Seven
FSB08B	FSB08MB	48"	Eight
FSB09B	FSB09MB	54"	Nine
FSB10B	FSB10MB	60"	Ten
FSB11B	FSB11MB	66"	Eleven
FSB12B	-	72"	Twelve
FSB13B	-	78"	Thirteen

SINGLE STICK LENGTHS

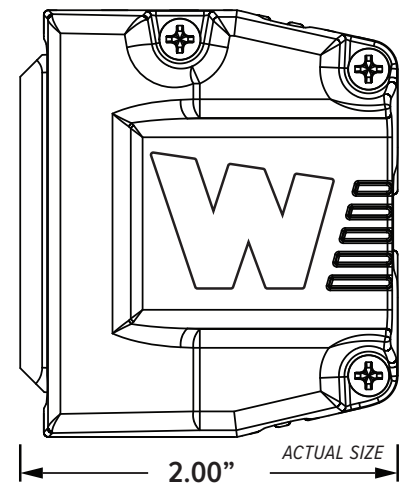

2.00" ACTUAL SIZE

Field Series
Side Profile

DIMENSIONS

FSB02B 2-Lamp
Front View

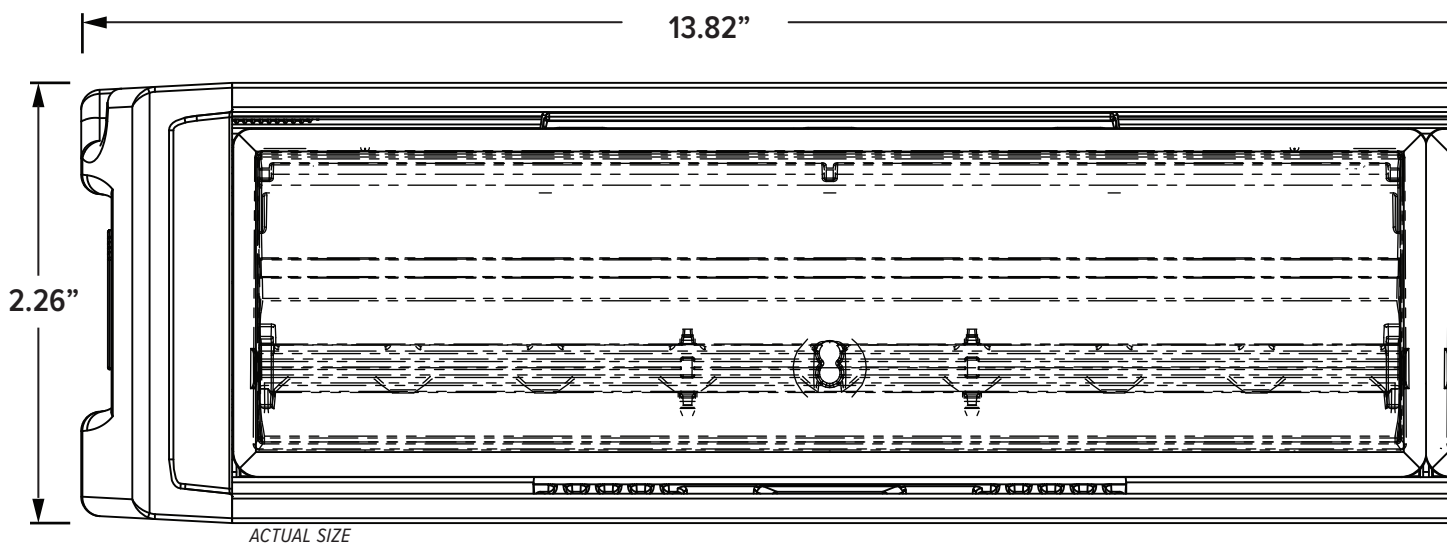

ACTUAL SIZE

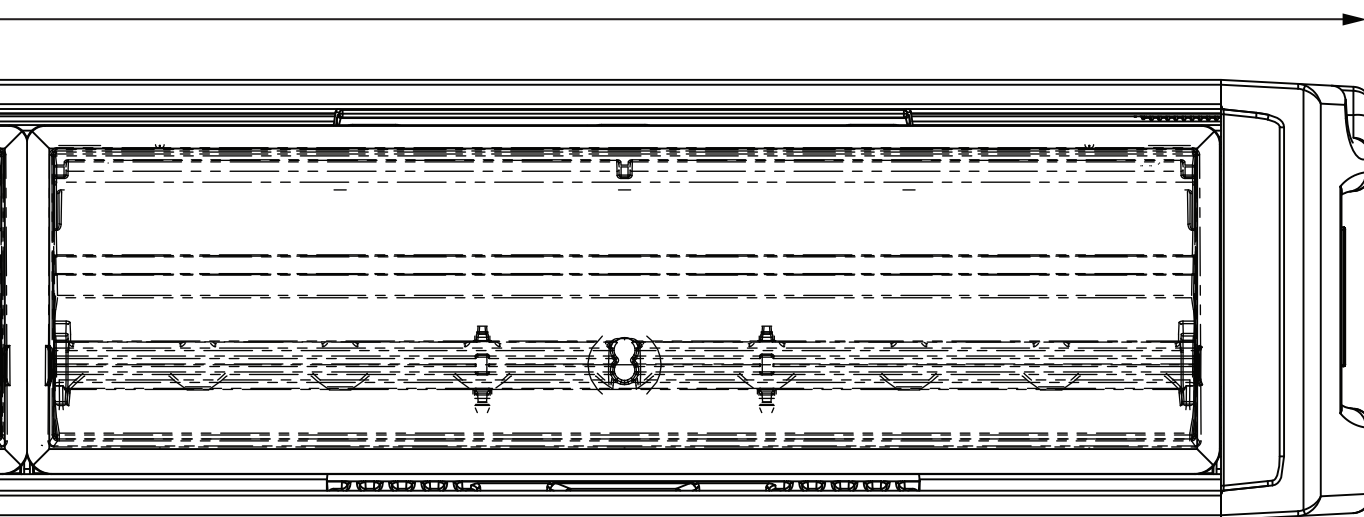
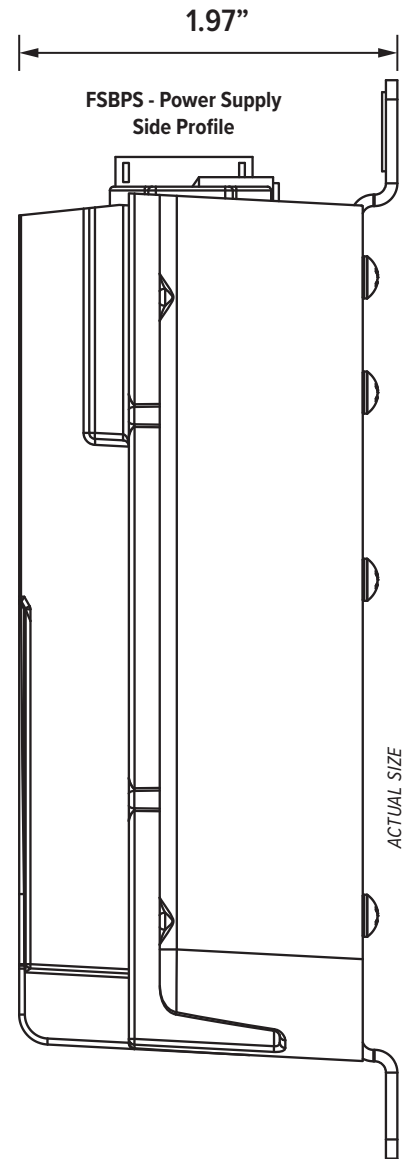
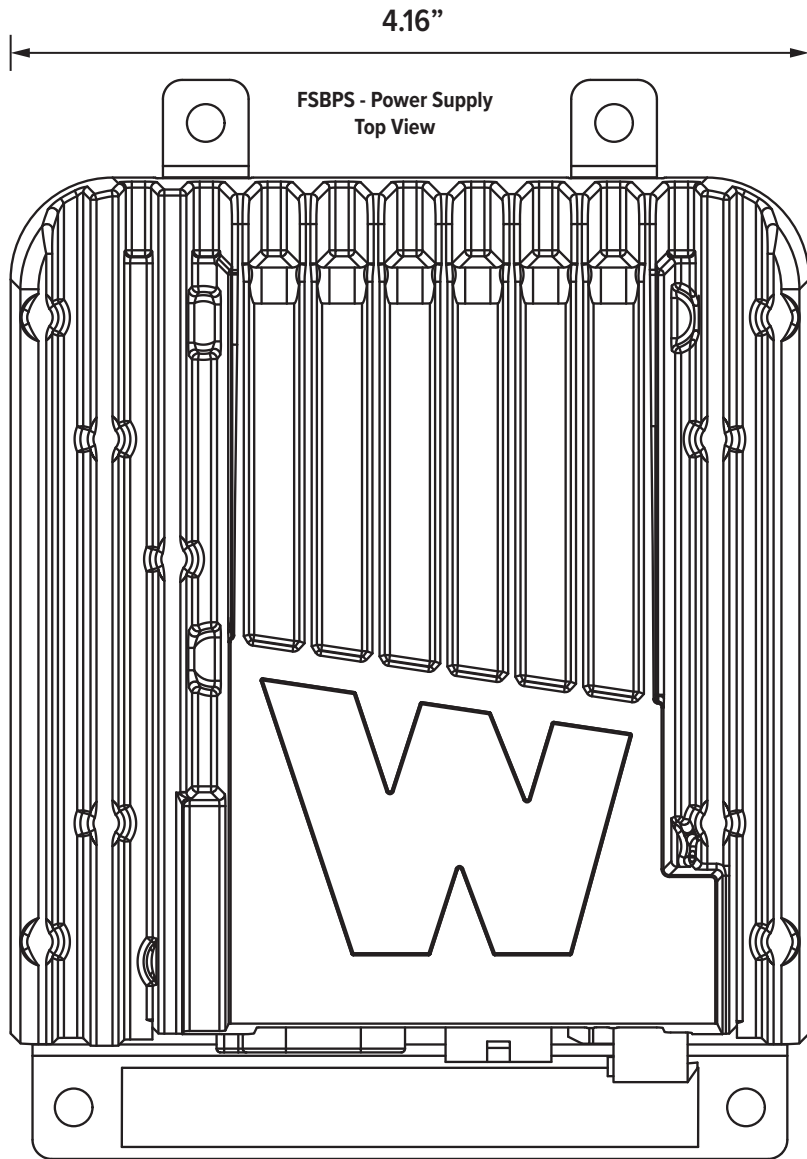

FIELD
SERIES™

WARNING: This product may contain chemicals known to the State of California to cause cancer and birth defects or other reproductive harm. For more information, visit whelen.com/regulatory.

WHELEN®
MANUFACTURED IN AMERICA

PROTECTING THOSE WHO PROTECT OTHERS

FIELD SERIES™

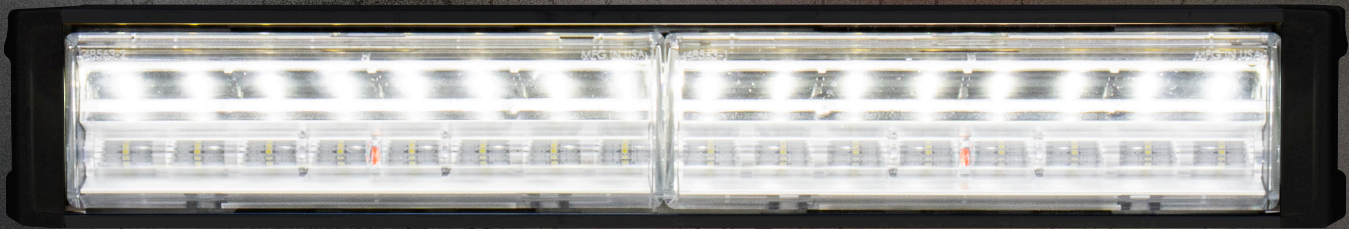

Trusted for more than 70 years to clear the way, illuminate
+ the scene, and send you home safe night after night to the +
ones you love. We never left and we're here to stay.

WHELEN[®]
MANUFACTURED IN AMERICA

www.whelen.com

@WhelenENG



NASCAR[™]
OFFICIAL WARNING LIGHTS

Preferred Warning Lights of 

Whelen Engineering Company
(860) 526-9504
www.whelen.com

Whelen Engineering reserves the
right to upgrade and improve
products without notice.

© 2024 Whelen Engineering Company, Inc.
Printed in U.S.A.
Code No. B13492D - 07/2024

All products proudly designed, manufactured,
and assembled in the U.S.A.
• ISO 9001 Registered QMS